

AIRPHO

Quick Installation Guide

300Mbps Wireless N ADSL2+ Modem Router

Model : AR-D200

Airpho Technology Co.,Ltd
Web: www.airpho.com

Package Contents

- 1 x ADSL2+Modem Router AR-D200
- 1 x Power Adapter
- 1 x ADSL Splitter
- 1 x Ethernet Cable
- 2 x RJ11 Phone Cable

(Notes: The provided power adapter may vary depending on the country of purchase.)



RECYCLABLE



MADE IN CHINA

Product's **Declaration of Conformity** is available on Airpho Official website, please check www.airpho.com.

Specifications are subject to change without notice.

AIRPHO is a registered trademark of Airpho Technology Co.,Ltd.

Other brands and product names are trademarks or registered trademarks of their respective holders.

Copyright©2018 Airpho Technology Co., Ltd. All rights reserved.

Table of Contents

Quick Installation Guide

English	1
Čeština	5
Deutsch	9
Español	13
Français	17
Italiano	21
Polski	25
Português	29
Русский	33
Türkçe	37

1 Connecting the Hardware

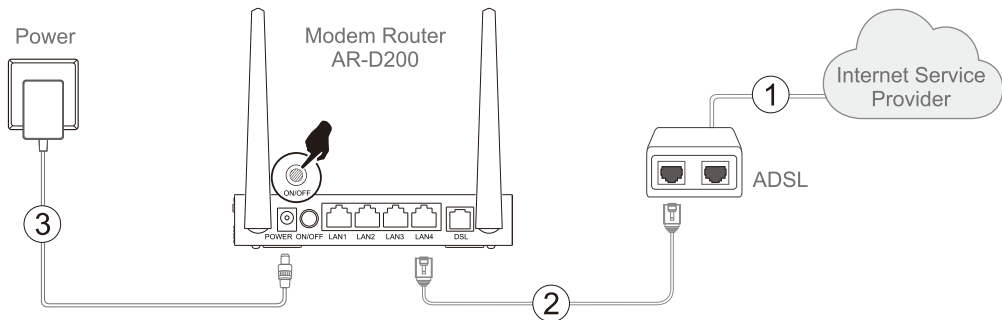

Step 1

Connect the ADSL splitter to the phone jack.

Step 2



Connect the modem router to the ADSL splitter.

Step 3

Connect the power adapter to the modem router and turn on the modem router by pressing the ON/OFF button on the rear panel.

Notes:

You can verify that the hardware connections are correct by checking the following LEDs.

	Power	ON
	ADSL	Flashing
	Wireless	ON

2 Connecting to the Modem Router

Connect your computer to the modem router wirelessly or with an Ethernet cable.

Wired

Connect the computer to the LAN ports (LAN1, LAN2, LAN3 or LAN4) on your modem router with an Ethernet cable. The LAN LED should light up correspondingly.

Wireless

- a. Find the SSID (network name) and Wireless Password printed on the product label at the bottom of the modem router.

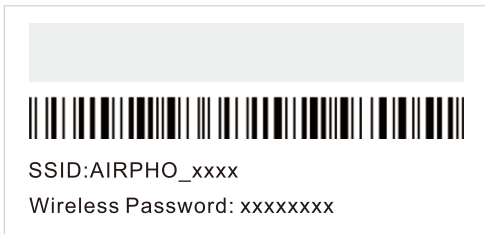

- b. Go to Wi-Fi Setting of your computer or smart device, then select the router's SSID to join the network.

3 Configuring Your Modem Router

- 3.1. Launch a web browser and visit **192.168.1.1**, a login window should display. Use **admin** for both username and password, and then click **Login** (As shown in image 1).
- 3.2. Select **Wizard** from the menu. Fill in the required parameters based on the information provided by your ISP and click **Next** (As shown in image 2).

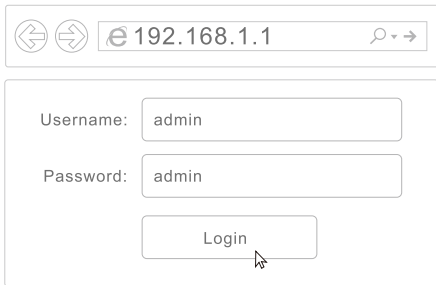

A screenshot of a web browser's address bar containing the URL `192.168.1.1`. Below the address bar is a login form with two input fields: "Username:" containing the text "admin" and "Password:" containing the text "admin". Below these fields is a "Login" button with a mouse cursor pointing to it.

(Image 1)

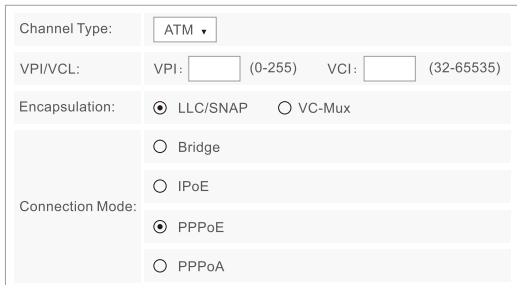

A screenshot of a configuration page. The "Channel Type" is set to "ATM". The "VPI/VCL" section has two input fields: "VPI:" (0-255) and "VCL:" (32-65535). The "Encapsulation" section has two radio buttons: "LLC/SNAP" (selected) and "VC-Mux". The "Connection Mode" section has three radio buttons: "Bridge", "IPoE", and "PPPoE" (selected). Below the form is a "Next" button.

(Image 2)

3.3. Setup your wireless parameters and click **Next** to continue (As shown in image 3).

3.4. Verify your settings , and click **Apply Changes** to save and complete the configuration (As shown in image 4). You may close the window and enjoy surfing!

WLAN: Enable Disable

Band: 2.4GHz(B+G+N) ▼

SSID: AIRPHO_****

Encryption: None ▼

Prev Next

(Image 3)

Settings as follow:	
VPI:	1
VCI:	35
Encapsulation:	LLC/SNAP
Channel Mode:	PPPoE
IP Protocol:	Ipv4
PPP username:	dasbe@dss
PPP password:	root
DNS setting:	DNS Automatically
WALN:	Enable

Prev Apply Changes Cancel

(Image 4)

Support

If the modem router does not connect to the Internet, you may refer to the User Manual and FAQ, which are available on Airpho official website: www.airpho.com

1 Připojení hardware

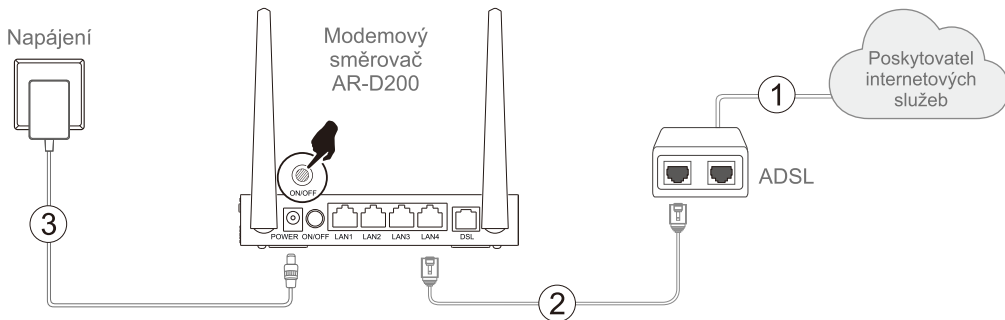

Krok 1

Připojte rozbočovač ADSL k telefonní zásuvce.

Krok 2

Připojte modemový směrovač k rozbočovači ADSL.

Krok 3

Připojte napájecí adaptér k modemovému směrovači a stisknutím tlačítka ON/OFF na zadním panelu modemový směrovač zapněte.

Poznámky:

Správné připojení hardware lze zkontrolovat pomocí následujících indikátorů LED.

	Napájení	Svíí
	ADSL	Bliká
	Bezdrátové připojení	Svíí

2 Připojení k modemovému směrovači

Připojte počítač k modemovému směrovači bezdrátově nebo pomocí ethernetového kabelu.

Kabelové připojení

Pomocí ethernetového kabelu připojte počítač k portům LAN (LAN1, LAN2, LAN3 nebo LAN4) na modemovém směrovači. Poté by se měl rozsvítit indikátor LED LAN.

Bezdrátové připojení

a) Zjistěte identifikátor SSID (název sítě) a heslo bezdrátové sítě vytištěné na štítku výrobku na spodní straně modemového směrovače.

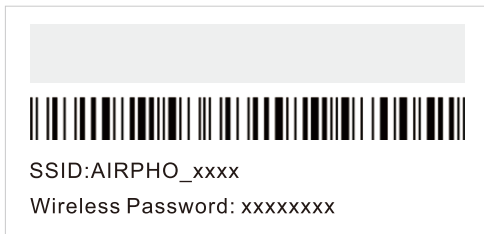

b) Na počítači nebo inteligentním zařízení přejděte do nastavení sítě Wi-Fi, poté vyberte identifikátor SSID směrovače a připojte se k síti.

3 Nastavení modemového směrovače

- 3.1. Spustíte internetový prohlížeč a zadejte adresu **192.168.1.1**. Poté se zobrazí přihlašovací okno. Jako uživatelské jméno i heslo zadejte text „**admin**“ a klikněte na tlačítko **Login** (jak je uvedeno na obrázku 1).
- 3.2. V nabídce vyberte možnost **Wizard**. Na základě informací od poskytovatele internetových služeb vyplňte požadované parametry a klikněte na tlačítko **Next** (jak je uvedeno na obrázku 2).

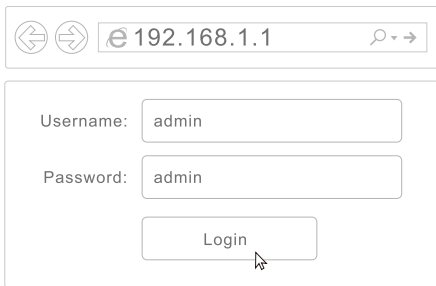

← → 192.168.1.1 🔍 →

Username:

Password:

(Obrázek 1)

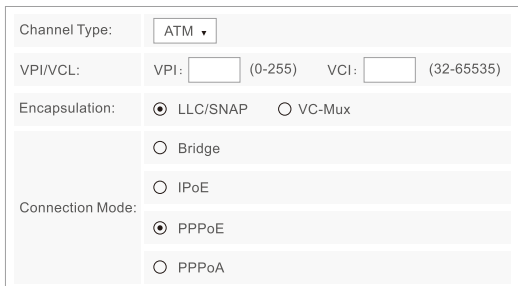

Channel Type:

VPI/VCL: VPI: (0-255) VCI: (32-65535)

Encapsulation: LLC/SNAP VC-Mux

Bridge

IPoE

Connection Mode: PPPoE PPPoA

(Obrázek 2)

3.3. Nastavte parametry bezdrátové sítě a pokračujte kliknutím na tlačítko **Next** (jak je uvedeno na obrázku 3).

3.4. Ověřte nastavení a pro jeho uložení a dokončení klikněte na tlačítko **Apply Changes** (jak je uvedeno na obrázku 4). Zavřete okno a užívejte si surfování!

WLAN:	<input checked="" type="radio"/> Enable <input type="radio"/> Disable
Band:	2.4GHz(B+G+N) ▼
SSID:	AIRPHO_xxxx
Encryption:	None ▼

Prev Next

(Obrázek 3)

Settings as follow:	
VPI:	1
VCI:	35
Encapsulation:	LLC/SNAP
Channel Mode:	PPPoE
IP Protocol:	Ipv4
PPP username:	dasbe@dsr
PPP password:	root
DNS setting:	DNS Automatically
WALN:	Enable

Prev Apply Changes Cancel

(Obrázek 4)

Podpora

Pokud se modemový směrovač nepřipojí k internetu, přečtěte si uživatelskou příručku a nejčastější dotazy, které jsou k dispozici na oficiálních webových stránkách společnosti Airpho: www.airpho.com

1 Anschluss der Hardware

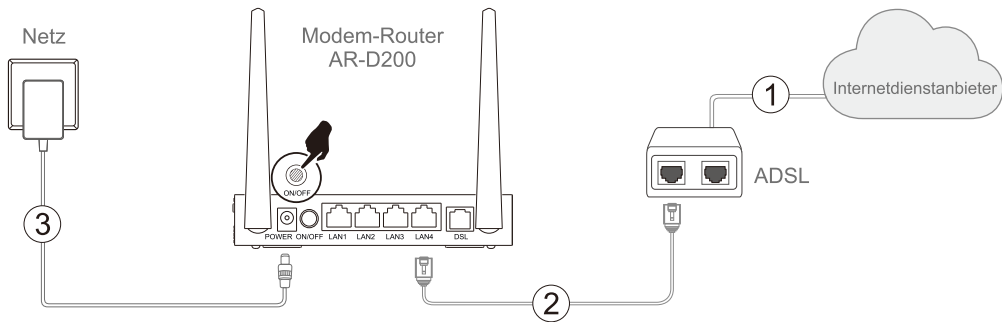

Schritt 1

Schließen Sie den ADSL-Splitter an die Telefonsteckdose an.

Schritt 2



Verbinden Sie den Modem-Router mit dem ADSL-Splitter.

Schritt 3

Verbinden Sie den Netzadapter mit dem Modem-Router und schalten Sie den Modem-Router ein, indem Sie den Ein-/Auswechsler (ON/OFF) auf der Rückseite drücken.

Anmerkungen:

Sie können überprüfen, dass die Hardwareverbindungen korrekt sind, indem Sie die folgenden LEDs prüfen.

	Netz	Ein
	ADSL	Blinkend
	Drahtlos	Ein

2 Verbindung mit dem Modem-Router

Verbinden Sie Ihren Computer drahtlos oder mit einem Netzkabel mit dem Modem-Router.

Drahtgebunden

Verwenden Sie ein Netzkabel, um Ihren Computer mit einem der LAN-Anschlüsse (LAN1, LAN2, LAN3 oder LAN4) an Ihrem Modem-Router zu verbinden. Die entsprechende LAN-LED sollte aufleuchten.

Drahtlos

- Suchen Sie nach der SSID (dem Netzwerknamen) und dem WLAN-Passwort, die auf dem Produktschild auf der Unterseite des Modem-Routers aufgedruckt sind.

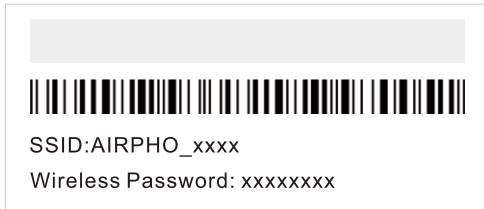

- Rufen Sie die WLAN-Einstellung Ihres Computers oder Ihres Smartphones/Tablets auf. Wählen Sie dann die SSID des Routers aus, um eine Netzwerkverbindung herzustellen.

3 Konfiguration Ihres Modem-Routers

- 3.1. Starten Sie einen Web-Browser und geben Sie **192.168.1.1** ein. Es sollte dann ein Anmeldefenster angezeigt werden. Geben Sie sowohl für den Benutzernamen als auch das Passwort "**admin**" ein. Klicken Sie dann auf **Login** (wie in Bild 1 dargestellt).
- 3.2. Wählen Sie den Assistenten (**Wizard**) aus dem Menü aus. Geben Sie die Informationen ein, die Ihnen Ihrem Internetdienstanbieter zur Verfügung gestellt wurden und klicken Sie dann auf **Next** (wie in Bild 2 dargestellt).

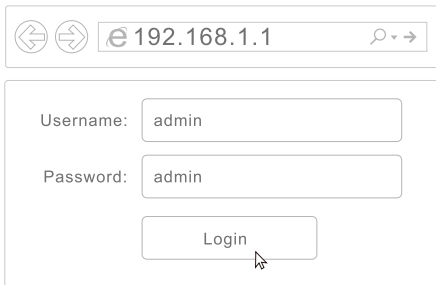

⏪ ⏩ 🔍 ↘

Username:

Password:

(Bild 1)

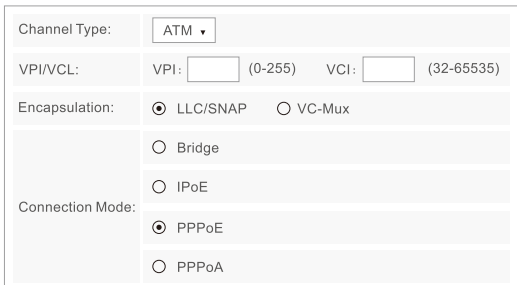

Channel Type:

VPI/VCL: VPI: (0-255) VCI: (32-65535)

Encapsulation: LLC/SNAP VC-Mux

Bridge

IPoE

Connection Mode: PPPoE PPPoA

(Bild 2)

- 3.3. Richten Sie Ihre WLAN-Verbindung ein und klicken Sie dann **Next**, um fortzufahren (wie in Bild 3 dargestellt).
- 3.4. Überprüfen Sie Ihre Einstellungen und klicken Sie auf "**Apply Changes**" zum Speichern und Abschließen Ihrer Konfiguration (wie in Bild 4 dargestellt). Sie können nun das Fenster schließen und das Surfen im Internet genießen!

WLAN:	<input checked="" type="radio"/> Enable <input type="radio"/> Disable
Band:	2.4GHz(B+G+N) ▼
SSID:	AIRPHO_xxxx
Encryption:	None ▼

Prev Next

(Bild 3)

Settings as follow:	
VPI:	1
VCI:	35
Encapsulation:	LLC/SNAP
Channel Mode:	PPPoE
IP Protocol:	Ipv4
PPP username:	dasbe@dsr
PPP password:	root
DNS setting:	DNS Automatically
WALN:	Enable

Prev Apply Changes Cancel

(Bild 4)

Support

Wenn sich der Modem-Router nicht mit dem Internet verbindet, können Sie im Benutzerhandbuch und den FAQs nachschlagen, die auf der offiziellen Website von Airpho zur Verfügung stehen: www.airpho.com.

1 Conexión del Hardware

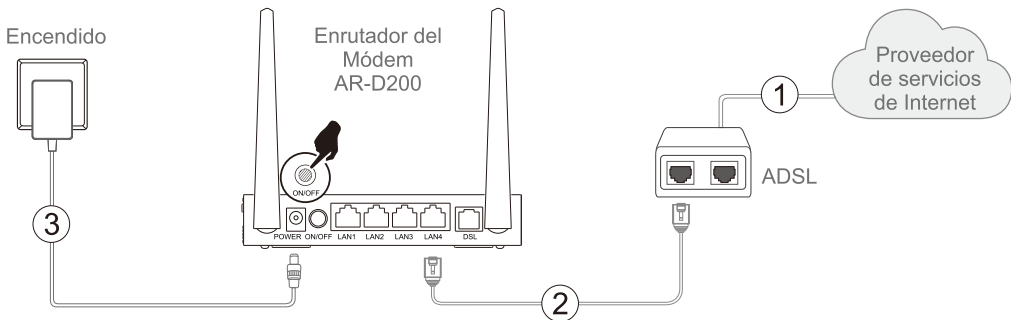

Paso 1

Conecte el divisor ADSL a la toma del teléfono.

Paso 2

Conecte el enrutador del módem al divisor ADSL.

Paso 3

Conecte el adaptador de corriente al enrutador del módem y ponga en marcha el enrutador presionando el botón ON/OFF en el panel posterior.

Notas:

Puede comprobar que las conexiones de hardware sean correctas comprobando los siguientes LED.

	Encendido	ACTIVADO
	ADSL	Parpadeo
	Inalámbrico	ACTIVADO

2 Conexión al enrutador del módem

Conecte su ordenador al enrutador del módem de forma inalámbrica o con un cable de Ethernet.

Con cable

Conecte el ordenador a los puertos LAN (LAN1, LAN2, LAN3 o LAN4) del enrutador del módem con un cable Ethernet. El LED del puerto LAN se encenderá consecuentemente..

Inalámbrico

- Busque el SSID (nombre de la red) y la contraseña inalámbrica en la etiqueta del producto, ubicada en la parte inferior del enrutador del módem

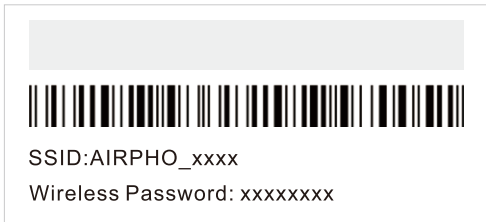

- Vaya a Configuración de Wi-Fi de su ordenador o dispositivo inteligente y seleccione el SSID del enrutador para unirse a la red.

3 Configuración del enrutador del módem

- 3.1. Abra el navegador web y entre en la siguiente dirección: **192.168.1.1**, tras lo cual debería abrirse una ventana de inicio de sesión. Use **admin** tanto para el nombre de usuario como para la contraseña, y luego haga clic en (**Login**) Iniciar sesión (tal como se muestra en la imagen 1).
- 3.2. Seleccione el Asistente del menú (**Wizard**). Complete los parámetros necesarios en función de la información que su ISP le haya proporcionado y haga clic en **Next** (como se muestra en la imagen 2).

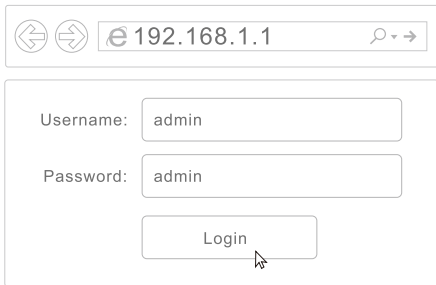

← → 192.168.1.1 🔍 →

Username:

Password:

(Imagen 1)

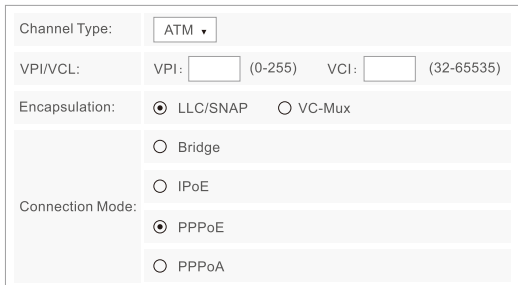

Channel Type:

VPI/VCL: VPI: (0-255) VCI: (32-65535)

Encapsulation: LLC/SNAP VC-Mux

Bridge

IPoE

Connection Mode: PPPoE PPPoA

(Imagen 2)

3.3. Configure sus parámetros inalámbricos y haga clic en **Next** para continuar (como se muestra en la imagen 3).

3.4. Verifique su configuración y haga clic en **Apply Changes** para guardar y completar la configuración (tal como se muestra en la imagen 4). ¡Ya puede cerrar la ventana y disfrutar de la navegación!

WLAN:	<input checked="" type="radio"/> Enable <input type="radio"/> Disable
Band:	2.4GHz(B+G+N) ▼
SSID:	AIRPHO_xxxx
Encryption:	None ▼

Prev Next

(Imagen 3)

Settings as follow:	
VPI:	1
VCI:	35
Encapsulation:	LLC/SNAP
Channel Mode:	PPPoE
IP Protocol:	Ipv4
PPP username:	dasbe@dsr
PPP password:	root
DNS setting:	DNS Automatically
WLAN:	Enable

Prev Apply Changes Cancel

(Imagen 4)

Soporte

Si el enrutador de módem no se conecta a Internet, puede consultar el Manual de usuario y las Preguntas frecuentes, que encontrará disponibles en el sitio web oficial de Airpho: www.airpho.com

1 Branchement du matériel

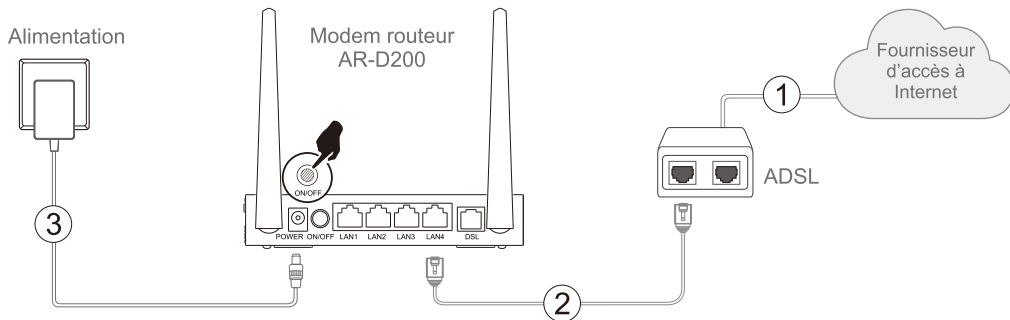

Étape 1

Branchez le répartiteur ADSL dans la prise téléphonique.

Étape 2



Raccordez le modem routeur au répartiteur ADSL.

Étape 3

Branchez l'adaptateur secteur au modem routeur, puis allumez le modem routeur en appuyant sur le bouton ON/OFF situé à l'arrière.

Remarques :

Assurez-vous que les branchements du matériel sont corrects en vérifiant l'état des voyants suivants.

	Alimentation	Allumé
	ADSL	Clignotant
	Wi-Fi	Allumé

2 Raccordement au modem routeur

Raccordez votre ordinateur au modem routeur via le Wi-Fi ou avec un câble Ethernet.

Connexion par câble

Raccordez votre ordinateur à un port LAN (LAN1, LAN2, LAN3 ou LAN4) de votre modem routeur avec un câble Ethernet. Le voyant du réseau LAN devrait s'allumer au même moment.

Wi-Fi

- Repérez le SSID (nom du réseau) et le mot de passe du Wi-Fi imprimés sur l'étiquette du produit située à l'arrière du modem routeur.

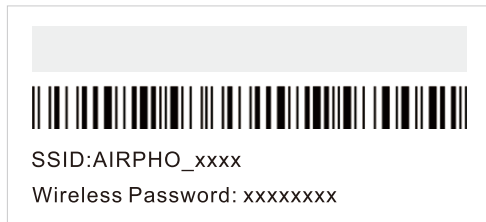

- Rendez-vous dans les Réglages Wi-Fi de votre ordinateur ou de votre appareil connecté, puis sélectionnez le SSID du routeur pour accéder au réseau.

3 Configuration de votre modem routeur

- 3.1. Ouvrez un navigateur Web et rendez-vous sur **192.168.1.1** ; une fenêtre de connexion devrait apparaître. Sélectionnez **Admin** (Administrateur) pour le nom d'utilisateur et le mot de passe, puis cliquez sur **Login** (comme montré dans l'image 1).
- 3.2. Sélectionnez **Wizard** dans le menu. Renseignez les paramètres requis en vous basant sur les informations fournies par votre FAI, puis cliquez sur **Next** (comme montré dans l'image 2).

Username:

Password:

(Image 1)

Channel Type:

VPI/VCL: VPI: (0-255) VCI: (32-65535)

Encapsulation: LLC/SNAP VC-Mux

Bridge

IPoE

Connection Mode: PPPoE PPPoA

(Image 2)

- 3.3. Configurez vos paramètres Wi-Fi, puis cliquez sur **Next** pour continuer (comme montré dans l'image 3).
- 3.4. Vérifiez vos réglages, puis cliquez sur **Apply Changes** pour sauvegarder et mettre fin à la configuration (comme montré dans l'image 4). Vous pouvez maintenant fermer la fenêtre et profiter d'Internet !

WLAN:	<input checked="" type="radio"/> Enable <input type="radio"/> Disable
Band:	2.4GHz(B+G+N) ▼
SSID:	AIRPHO_xxxx
Encryption:	None ▼

Prev Next

(Image 3)

Settings as follow:	
VPI:	1
VCI:	35
Encapsulation:	LLC/SNAP
Channel Mode:	PPPoE
IP Protocol:	Ipv4
PPP username:	dasbe@dsr
PPP password:	root
DNS setting:	DNS Automatically
WALN:	Enable

Prev Apply Changes Cancel

(Image 4)

Assistance

Si le modem routeur ne se connecte pas à Internet, référez-vous au Manuel d'utilisation et aux questions fréquentes (FAQ) disponibles sur le site Web officiel d'Airpho : www.airpho.com

1 Collegamento dell'hardware

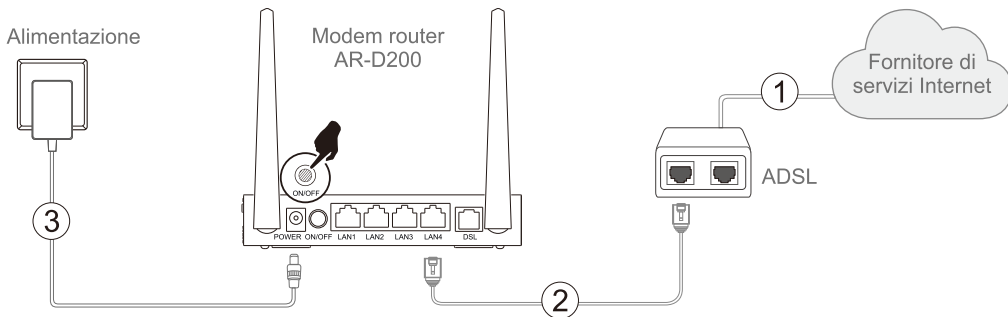

Passaggio 1

Collegare lo splitter ADSL al jack del telefono.

Passaggio 2



Collegare il modem router allo splitter ADSL.

Passaggio 3

Collegare l'adattore di alimentazione al modem router e attivare quest'ultimo premendo il pulsante ON/OFF sul pannello posteriore.

Note:

È possibile verificare se i collegamenti hardware sono corretti tramite i seguenti LED.

	Alimentazione	ATTIVO
	ADSL	Lampeggiante
	Modalità wireless	ATTIVO

2 Collegamento al modem router

Collegare il computer al modem router in modalità wireless o tramite un cavo Ethernet.

Modalità cablata

Collegare il computer alle porte LAN (LAN1, LAN2, LAN3 o LAN4) sul modem router con un cavo Ethernet. Il LED LAN si accende di conseguenza.

Modalità wireless

- Cercare l'SSID (nome rete) e la password della rete wireless stampati sull'etichetta del prodotto nella sezione inferiore del modem router.

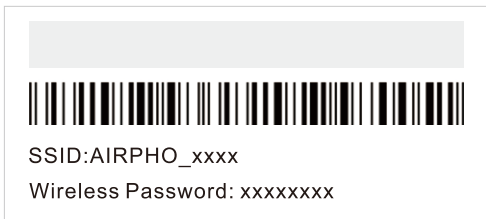

- Accedere alle Impostazioni Wi-Fi sul proprio computer o dispositivo intelligente, quindi selezionare l'SSID del router per accedere alla rete.

3 Configurazione del modem router

- 3.1. Avviare un Web browser e digitare **192.168.1.1**. Verrà visualizzata una finestra di accesso. Utilizzare **admin** per nome utente e password, quindi fare clic su **Login** (come illustrato nell'immagine 1).
- 3.2. Selezionare **Wizard** dal menu. Inserire i parametri richiesti in base alle informazioni fornite dal proprio fornitore di servizi Internet e fare clic su **Next** (come illustrato nell'immagine 2).

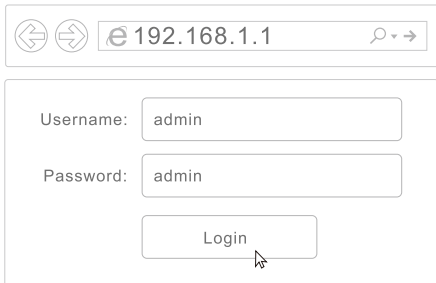

The image shows a web browser interface. At the top, the address bar contains the URL '192.168.1.1'. Below the address bar, there is a login form with two input fields: 'Username:' containing 'admin' and 'Password:' containing 'admin'. Below these fields is a 'Login' button with a mouse cursor pointing to it.

(Immagine 1)

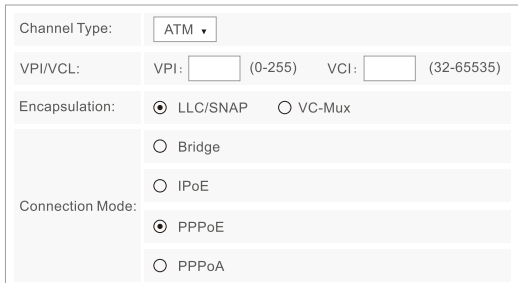

The image shows a configuration wizard form. It has several sections: 'Channel Type:' with a dropdown menu set to 'ATM'; 'VPI/VCL:' with two input fields for 'VPI:' (range 0-255) and 'VCI:' (range 32-65535); 'Encapsulation:' with radio buttons for 'LLC/SNAP' (selected) and 'VC-Mux'; and 'Connection Mode:' with radio buttons for 'Bridge', 'IPoE', 'PPPoE' (selected), and 'PPPoA'. A 'Next' button is located below the form.

(Immagine 2)

3.3. Impostare i parametri della rete wireless e fare clic su **Next** per continuare (come illustrato nell'immagine 3).

3.4. Verificare le impostazioni, quindi fare clic su **Apply Changes** per salvare e completare la configurazione (come illustrato nell'immagine 4). È ora possibile chiudere la finestra e iniziare a navigare su Internet.

WLAN:	<input checked="" type="radio"/> Enable <input type="radio"/> Disable
Band:	2.4GHz(B+G+N) ▼
SSID:	AIRPHO_xxx
Encryption:	None ▼

Prev Next

(Immagine 3)

Settings as follow:	
VPI:	1
VCI:	35
Encapsulation:	LLC/SNAP
Channel Mode:	PPPoE
IP Protocol:	Ipv4
PPP username:	dasbe@dsr
PPP password:	root
DNS setting:	DNS Automatically
WALN:	Enable

Prev Apply Changes Cancel

(Immagine 4)

Assistenza

Se il modem router non si collega a Internet, fare riferimento al Manuale dell'utente e alle domande frequenti disponibili sul sito Web ufficiale di Airpho: www.airpho.com.

1 Podłączanie urządzenia

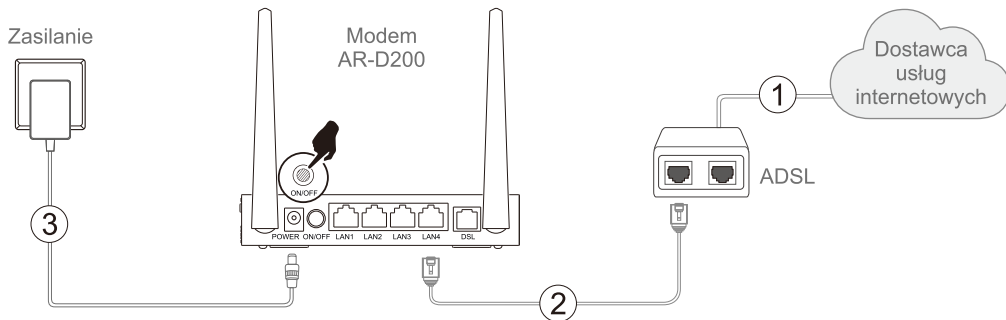

Krok 1

Podłącz filtr ADLS do gniazdka telefonicznego.

Krok 2

Podłącz modem do filtru ADSL.

Krok 3

Podłącz zasilacz do modemu i włącz modem przyciskiem ON/OFF znajdującym się na tylnym panelu.

Uwagi:

Prawidłowość podłączenia urządzenia możesz skontrolować sprawdzając diody.

 Zasilanie Wł.

 ADSL Miga

 Bezprzewodowe Wł.

2 Łączenie z modemem

Połącz komputer bo modemu bezprzewodowo lub kablem Ethernet.

Połączenie przewodowe

Podłącz komputer przewodem Ethernet do portu LAN (LAN1, LAN2, LAN3 lub LAN4) modemu. Powinien zaświecić się odpowiedni wskaźnik LAN.

Bezprzewodowe

a. Odszukaj identyfikator SSID (nazwa sieci) i hasło sieci bezprzewodowej podane na etykiecie na spodzie modemu.

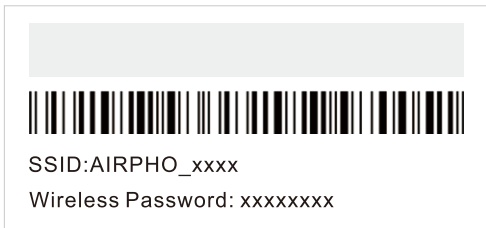

b. Aby połączyć się z siecią, przejdź do ustawień Wi-Fi komputera lub urządzenia przenośnego, następnie wybierz identyfikator SSID routera.

3 Konfiguracja modemu

- 3.1. Uruchom przeglądarkę internetową i wyświetl witrynę **192.168.1.1**. Powinno pojawić się okno logowania. Jako hasło i nazwę użytkownika wpisz „**admin**”, a następnie kliknij „**Login**” (rys. 1).
- 3.2. W menu wybierz Kreatora (**Wizard**). Uzupełnij wymagane parametry zgodnie z informacjami od dostawcy usług internetowych i kliknij przycisk **Next** (rys. 2).

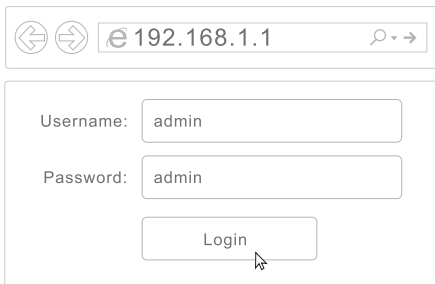

← → 192.168.1.1 🔍 →

Username: admin

Password: admin

Login

(Ilustracja 1)

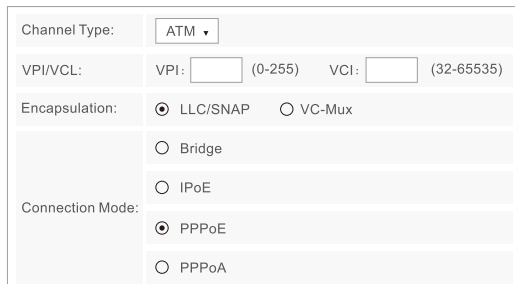

Channel Type: ATM ▾

VPI/VCL: VPI: [] (0-255) VCI: [] (32-65535)

Encapsulation: LLC/SNAP VC-Mux

Connection Mode: Bridge
 IPoE
 PPPoE
 PPPoA

Next

(Ilustracja 2)

3.3. Ustaw parametry sieci bezprzewodowej i kliknij przycisk **Next** (rys. 3), aby kontynuować.

3.4. Sprawdź ustawienia i kliknij przycisk **Apply Changes** (rys. 4), aby zapisać i zakończyć konfigurację.

Po wykonaniu powyższych czynności możesz zamknąć okno i przeglądać strony internetowe!

WLAN: Enable Disable

Banb: 2.4GHz(B+G+N) ▾

SSID: AIRPHO_xxxx

Encryption: None ▾

Prev Next

(Ilustracja 3)

Settings as follow:	
VPI:	1
VCI:	35
Encapsulation:	LLC/SNAP
Channel Mode:	PPPoE
IP Protocol:	Ipv4
PPP username:	dasbe@dsr
PPP password:	root
DNS setting:	DNS Automatically
WALN:	Enable

Prev Apply Changes Cancel

(Ilustracja 4)

Pomoc techniczna

Jeżeli modem nie łączy się z Internetem, możesz skorzystać z podręcznika użytkownika i odpowiedzi na często zadawane pytania, dostępnych na oficjalnej witrynie internetowej firmy Airpho: www.airpho.com.

1 Ligar o hardware

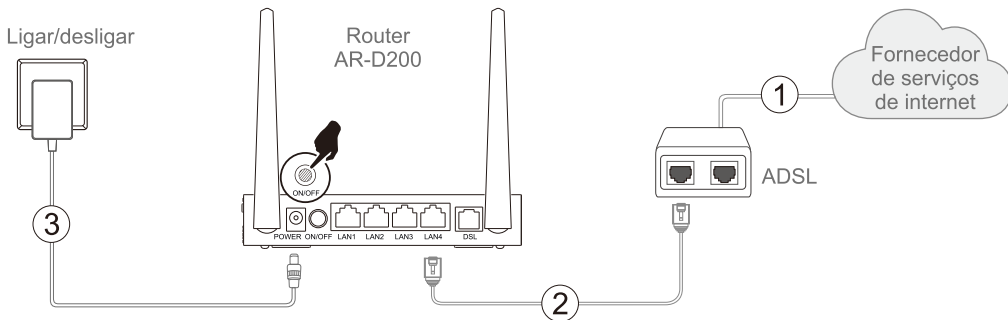

Passo 1

Ligue o repartidor de ADSL à tomada telefónica.

Passo 2



Ligue o router ao repartidor de ADSL.

Passo 3

Ligue o adaptador de alimentação ao router e ligue o router premindo o botão ON/OFF no painel traseiro.

Notas:

Pode verificar se as ligações do hardware estão corretas verificando os seguintes LED.

	Ligar/desligar	LIGADO
	ADSL	A piscar
	Sem fios	LIGADO

2 Ligar o router

Ligue o seu computador ao router via sem fios ou utilizando um cabo de Ethernet.

Com fios

Ligue o computador às portas LAN (LAN1, LAN2, LAN3 ou LAN4) no seu router utilizando um cabo de Ethernet. O LED LAN deverá acender-se de imediato.

Sem fios

- Encontre a SSID (nome da rede) e a Palavra-passe da rede sem fios impressos no rótulo do produto na parte inferior do router.

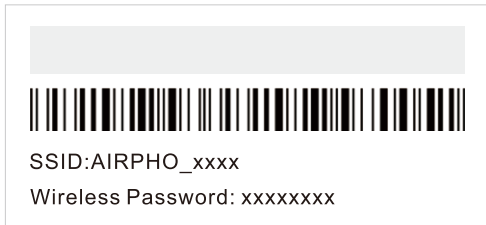

- Vá a Definições da rede Wi-Fi no seu computador ou dispositivo inteligente e selecione a SSID do router para se ligar à rede.

3 Configurar o seu router

- 3.1. Abra um browser e visite **192.168.1.1**; deverá surgir uma janela de início de sessão. Utilize "**admin**" como nome de utilizador e palavra-passe e de seguida clique em "**Login**" (conforme indicado na Imagem 1).
- 3.2. Selecione o Assistente (**Wizard**) a partir do menu. Preencha os parâmetros necessários com base nas informações prestadas pelo seu ISP e clique em "**Next**" (conforme indicado na Imagem 2).

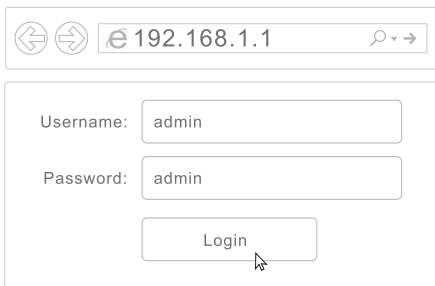

192.168.1.1

Username: admin

Password: admin

Login

(Imagem 1)

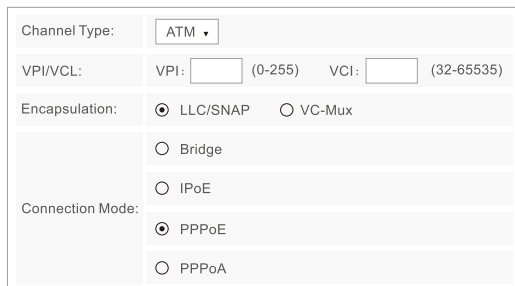

Channel Type: ATM

VPI/VCL: VPI: (0-255) VCI: (32-65535)

Encapsulation: LLC/SNAP VC-Mux

Connection Mode: Bridge IPoE PPPoE PPPoA

Next

(Imagem 2)

3.3. Configure os seus parâmetros da rede sem fios e clique em "**Next**" para continuar (conforme indicado na Imagem 3).

3.4. Verifique as suas definições e clique em "**Apply Changes**" para guardar e concluir a configuração (conforme indicado na Imagem 4). Pode encerrar a janela e desfrutar da internet!

WLAN:	<input checked="" type="radio"/> Enable <input type="radio"/> Disable
Band:	2.4GHz(B+G+N) ▼
SSID:	AIRPHO_xxxx
Encryption:	None ▼

Prev Next

(Imagem 3)

Settings as follow:	
VPI:	1
VCI:	35
Encapsulation:	LLC/SNAP
Channel Mode:	PPPoE
IP Protocol:	Ipv4
PPP username:	dasbe@dsr
PPP password:	root
DNS setting:	DNS Automatically
WLAN:	Enable

Prev Apply Changes Cancel

(Imagem 4)

Suporte

Se o router não ligar à internet, poderá consultar o Manual do utilizador e as Questões mais frequentes ("FAQ"), disponíveis no sítio Web oficial Airpho: www.airpho.com

1 Подключение оборудования



Шаг 1

Подключите ADSL-сплиттер к телефонной розетке.

Шаг 2



Подключите маршрутизатор со встроенным модемом к ADSL-сплиттеру.

Шаг 3

Подключите адаптер питания к маршрутизатору со встроенным модемом и включите его с помощью кнопки ON/OFF на задней панели.

Примечание:

Чтобы убедиться, что оборудование подключено корректно, используйте указанные ниже светодиодные индикаторы.

	Питание	Вкл.
	ADSL	Мигает
	Беспроводная сеть	Вкл.

2 Подключение к маршрутизатору со встроенным модемом

Подключите компьютер к маршрутизатору со встроенным модемом по беспроводной сети или с помощью Ethernet-кабеля.

Проводное подключение

Подключите компьютер к порту LAN (LAN1, LAN2, LAN3 или LAN4) на маршрутизаторе со встроенным модемом с помощью Ethernet-кабеля. Загорится светодиодный индикатор соответствующего порта LAN.

Беспроводное подключение

- a. Найдите идентификатор SSID (имя сети) и пароль беспроводной сети Wireless Password на этикетке, расположенной на нижней панели маршрутизатора со встроенным модемом.

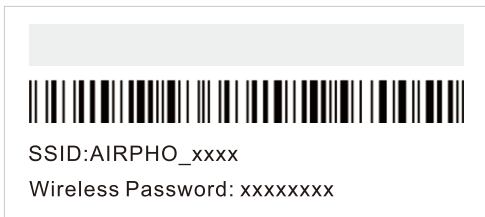

- b. На компьютере или другом устройстве с поддержкой беспроводных сетей откройте настройки подключения Wi-Fi и выберите идентификатор SSID маршрутизатора со встроенным модемом, чтобы выполнить подключение к сети.

3 Конфигурация маршрутизатора со встроенным модемом

- 3.1. Откройте веб-браузер и перейдите по адресу **192.168.1.1**. Откроется окно авторизации. Введите «**admin**» в качестве имени пользователя и пароля и нажмите кнопку «**Login**» (как показано на рис. 1).
- 3.2. В меню на экране выберите раздел «**Wizard**». Заполните все необходимые поля с помощью данных, предоставленных вашим интернет-провайдером, и нажмите кнопку «**Next**» (как показано на рис. 2).

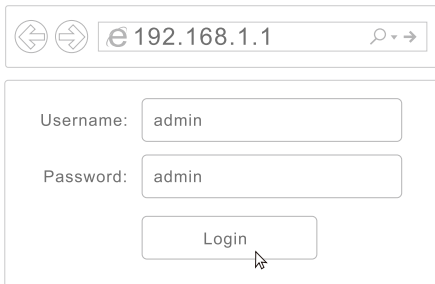

Username:

Password:

(Рисунок 1)

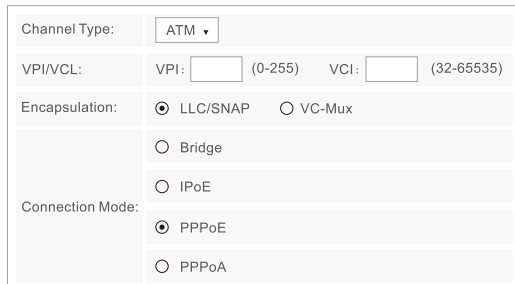

Channel Type:

VPI/VCL: VPI: (0-255) VCI: (32-65535)

Encapsulation: LLC/SNAP VC-Mux

Connection Mode: Bridge
 IPoE
 PPPoE
 PPPoA

(Рисунок 2)

3.3. Задайте параметры беспроводной сети и нажмите кнопку «**Next**», чтобы продолжить (как показано на рис. 3).

3.4. Проверьте настройки и нажмите кнопку «**Apply Changes**», чтобы их сохранить и завершить конфигурацию (как показано на рис. 4). Закройте окно. Хорошего времяпрепровождения!

WLAN:	<input checked="" type="radio"/> Enable <input type="radio"/> Disable
Band:	2.4GHz(B+G+N) ▾
SSID:	AIRPHO_xxxx
Encryption:	None ▾

Prev Next

(Рисунок 3)

Settings as follow:	
VPI:	1
VCI:	35
Encapsulation:	LLC/SNAP
Channel Mode:	PPPoE
IP Protocol:	Ipv4
PPP username:	dasbe@dsr
PPP password:	root
DNS setting:	DNS Automatically
WALN:	Enable

Prev Apply Changes Cancel

(Рисунок 4)

Техническая поддержка

Если вам не удалось подключить маршрутизатор со встроенным модемом к Интернету, обратитесь к Руководству пользователя и разделу часто задаваемых вопросов на официальном веб-сайте компании Airpho: www.airpho.com

1 Donanıma Bağlanma

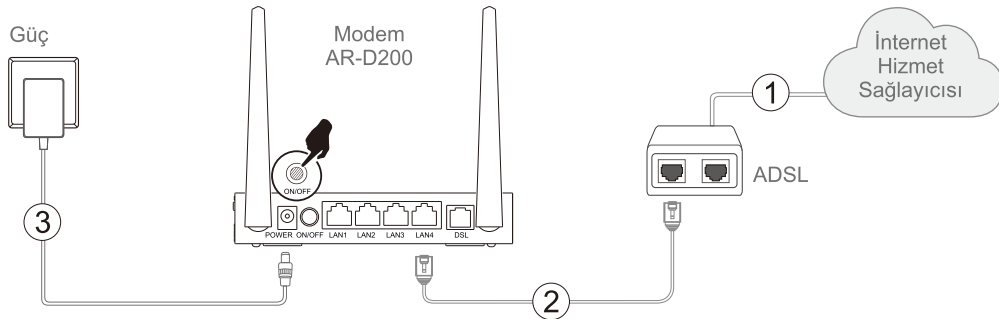

Adım 1

ADSL ayırıcısını telefon fişine bağlayın.

Adım 2

Modemi ADSL ayırıcısına bağlayın.

Adım 3

Güç adaptörünü modeme bağlayın ve arka paneldeki ON/OFF düğmesine basarak modemi açın.

Notlar:

Aşağıdaki LED'leri kontrol ederek donanım bağlantılarının doğru olup olmadığını doğrulayabilirsiniz.



Güç

AÇIK



ADSL

Yanıp sönüyor



Kablosuz

AÇIK

2 Modeme Bağlanma

Bilgisayarınızı modeme kablosuz olarak veya bir Ethernet kablosuyla bağlayın.

Kablolu

Bilgisayarı bir Ethernet kablosuyla modeminizin üzerindeki LAN girişlerinden birine (LAN1, LAN2, LAN3 veya LAN4) bağlayın. İlişkili LAN LED ışığı yanacaktır.

Kablosuz

a. Modemin altındaki ürün etiketinde yazılı olan SSID (ağ adı) ve Kablosuz Parolasını bulun.

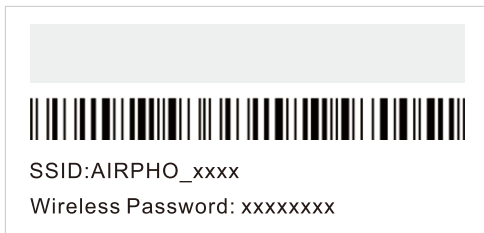

b. Bilgisayarınızın veya akıllı cihazınızın Wi-Fi Ayarına gidin ve ardından ağa katılmak için modemin SSID'sini seçin.

3 Modeminizi yapılandırma

- 3.1. Bir web tarayıcısı açın ve **192.168.1.1** adresine gidin, bir giriş penceresi görüntülenecektir. Kullanıcı adı ve parola için **admin** girin ve sonra **Login**'e tıklayın (Resim 1'de gösterildiği üzere).
- 3.2. Menüden **Wizard**'ı seçin. ISP'niz tarafından sağlanan bilgilere göre gerekli parametreleri girin ve **Next**'e tıklayın (Resim 2'de gösterildiği üzere).

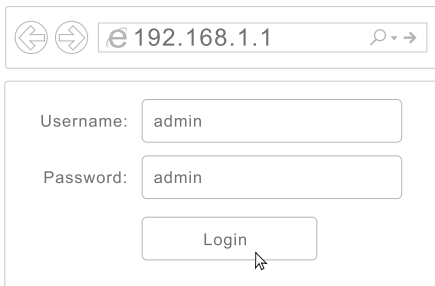

Username: admin

Password: admin

Login

(Resim 1)

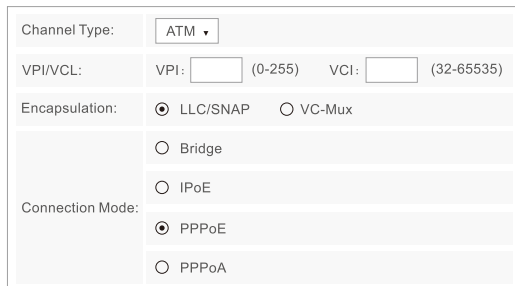

Channel Type: ATM

VPI/VCL: VPI: (0-255) VCI: (32-65535)

Encapsulation: LLC/SNAP VC-Mux

Connection Mode: Bridge IPoE PPPoE PPPoA

Next

(Resim 2)

3.3. Kablosuz parametrelerinizi ayarlayın ve devam etmek için **Next**'e tıklayın (Resim 3'te gösterildiği üzere).

3.4. Ayarlarınızı doğrulayın ve yapılandırmayı kaydedip tamamlamak için **Apply Changes**'e tıklayın (Resim 4'te gösterildiği üzere). Pencereyi kapatabilir ve internette gezinmenin keyfini çıkarabilirsiniz!

WLAN:	<input checked="" type="radio"/> Enable <input type="radio"/> Disable
Band:	2.4GHz(B+G+N) ▼
SSID:	AIRPHO_xxx
Encryption:	None ▼

Prev Next

(Resim 3)

Settings as follow:	
VPI:	1
VCI:	35
Encapsulation:	LLC/SNAP
Channel Mode:	PPPoE
IP Protocol:	Ipv4
PPP username:	dasbe@dsr
PPP password:	root
DNS setting:	DNS Automatically
WLAN:	Enable

Prev Apply Changes Cancel

(Resim 4)

Destek

Modem, internete bağlanmazsa Airpho resmi web sitesi www.airpho.com'da yer alan Kullanım Kılavuzuna ve SSS'ye bakabilirsiniz.



Scan for more information Or visit
our website : www.airpho.com

Airpho Technology Co.,Ltd

Web: www.airpho.com

Address: 3rd Floor, Building 15th, Wangtang Industry Park, Xili Street, Nanshan, Shenzhen, China